

a. Elektroder

Vi kan erbjuda ett brett sortiment av elektroder för motståndssvetsning. Nedan finns exempel på de vanligaste typerna. Vill du ha mer information, kontakta oss gärna.

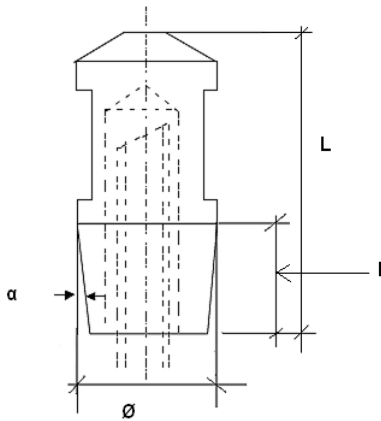

För att kunna leverera rätt elektrod behöver vi Tillverkare/ Art.nr eller enligt skissen:

- α = konvinkel eller konicitet
- \varnothing = största diameter på konan
- l = konans längd
- L = elektrodens total längd



Centrerad spets



Excentrisk spets



Pendelelektrod



S-formad

ELEKTRODER Ø 13mm, 5°

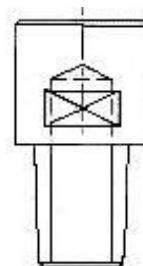
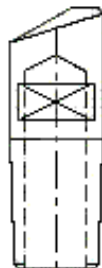
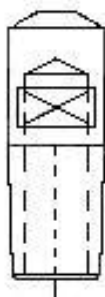

Centrisk Kona Ø 13 5°		
Längd mm	Artikel nr	Lager- vara
40	1253040	Ja
55	1253055	Ja
60	1253060	Ja
70	1253070	Nej
80	1253080	Ja
90	1253090	Nej
100	1253100	Ja

Excentrisk Kona Ø 13mm, 5°		
Längd mm	Artikel nr	Lager- vara
40	1353040	Ja
50	1353050	Nej
60	1353060	Nej
70	1353070	Ja
80	1353080	Nej
90	1353090	Nej
100	1353100	Nej

ELEKTRODER Ø 19mm, 5°

Centrisk Kona Ø 19mm, 5°		
Längd mm	Artikel nr	Lagervara
40	1259040	Nej
50	1259050	Nej
60	1259060	Nej
70	1259070	Ja
80	1259080	Nej
90	1259090	Nej
100	1259100	Nej

Excentrisk Kona Ø 19mm, 5°		
Längd mm	Artikel nr	Lager- vara
40	1359040	Ja
50	1359050	Nej
60	1359060	Nej
70	1359070	Ja
80	1359080	Nej
90	1359090	Nej
100	1359100	Nej

Plan Kona Ø 19mm, 5°		
Längd mm	Artikel nr	Lager- vara
40	1159040	Nej
50	1159050	Nej
60	1159060	Nej
70	1159070	Nej
80	1159080	Nej
90	1159090	Nej
100	1159100	Nej
140	1159140	Nej

a. Elektroder

ELEKTRODER LUNA Ø 13mm, Kona 1:10

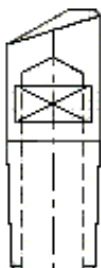
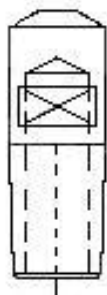

Centrisk Kona Ø 13 mm, 1:10		
Längd mm	Artikel nr	Lager- vara
40	61131-1	Ja
45	61131-2	Nej
50	61131-3	Nej
55	61131-4	Nej
60	61131-5	Ja
65	61131-6	Nej
70	61131-7	Nej
75	61131-8	Nej
80	61131-9	Nej
85	61131-10	Nej
90	61131-11	Nej
95	61131-12	Nej
100	61131-13	Ja

Excentrisk Kona Ø 13 mm, 1:10		
Längd mm	Artikel nr	Lager- vara
40	61134-1	Ja
45	61134-2	Nej
50	61134-3	Nej
55	61134-4	Nej
60	61134-5	Ja
65	61134-6	Nej
70	61134-7	Nej
75	61134-8	Nej
80	61134-9	Nej
85	61134-10	Nej
90	61134-11	Nej
95	61134-12	Nej
100	61134-13	Ja

ELEKTRODER LUNA Ø 16mm, Kona 1:10

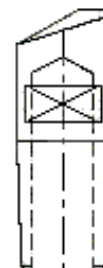
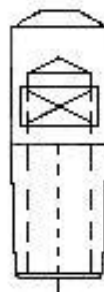

Centrisk Kona Ø 16 mm, 1:10		
Längd mm	Artikel nr	Lager- vara
40	61130-1	Ja
45	61130-2	Nej
50	61130-3	Nej
55	61130-4	Nej
60	61130-5	Nej
65	61130-6	Nej
70	61130-7	Nej
75	61130-8	Nej
80	61130-9	Ja
85	61130-10	Nej
90	61130-11	Nej
95	61130-12	Nej
100	61130-13	Nej

Excentrisk Kona Ø 16 mm, 1:10		
Längd mm	Artikel nr	Lager- vara
40	61133-1	Ja
45	61133-2	Nej
50	61133-3	Ja
55	61133-4	Nej
60	61133-5	Nej
65	61133-6	Nej
70	61133-7	Nej
75	61133-8	Nej
80	61133-9	Nej
85	61133-10	Nej
90	61133-11	Ja
95	61133-12	Nej
100	61133-13	Nej

ELEKTRODER LUNA Ø 19mm, Kona 1:10

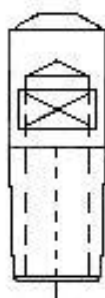

Centrisk Kona Ø 19 mm, 1:10		
Längd mm	Artikel nr	Lager- vara
40	61129-1	Ja
45	61129-2	Nej
50	61129-3	Ja
55	61129-4	Nej
60	61129-5	Ja
65	61129-6	Nej
70	61129-7	Nej
75	61129-8	Nej
80	61129-9	Nej
85	61129-10	Nej
90	61129-11	Nej
95	61129-12	Nej

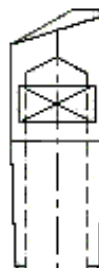

Excentrisk Kona Ø 19 mm, 1:10		
Längd mm	Artikel nr	Lager- vara
40	61132-1	Ja
45	61132-2	Nej
50	61132-3	Ja
55	61132-4	Nej
60	61132-5	Nej
65	61132-6	Nej
70	61132-7	Nej
75	61132-8	Nej
80	61132-9	Nej
85	61132-10	Nej
90	61132-11	Nej
95	61132-12	Nej
100	61132-13	Nej

ELEKTRODER TECNA Ø 13mm, Kona 5°

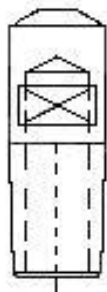

Centrisk Kona Ø 13mm, 5°		
Längd mm	Artikel nr	Lager- vara
40	2253040	Nej

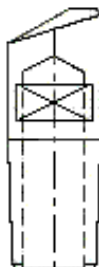

Excentrisk Kona Ø 13mm, 5°		
Längd mm	Artikel nr	Lager- vara
40	2353040	Nej

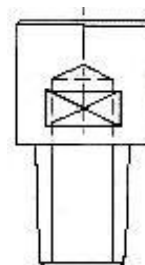

Plan Kona Ø 13mm, 5°		
Längd mm	Artikel nr	Lager- vara
40	2153040	Nej

ELEKTRODER TECNA Ø 16mm, Kona Ø 14,8mm, 5°

Centrisk Ø 16mm, Kona Ø 14,8mm, 5°		
Längd mm	Artikel nr	Lager- vara
43	981-0422-43	Nej

Excentrisk Ø 16mm, Kona Ø 14,8mm, 5°		
Längd mm	Artikel nr	Lager- vara
43	981-0423-43	Nej

ELEKTRODER TECNA Ø 22mm, Kona Ø 19mm, 5°

Centrisk Ø 22mm, Kona Ø 19mm, 5°		
Längd mm	Artikel nr	Lager- vara
70	2259070	Nej

Excentrisk Ø 22mm, Kona Ø 19mm, 5°		
Längd mm	Artikel nr	Lager- vara
70	2359070	Nej

Plan Ø 22mm, Kona Ø 19mm, 5°		
Längd mm	Artikel nr	Lager- vara
70	2159070	Nej

a. Elektroder

ELEKTRODER IBEROBOT

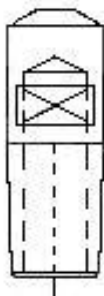

T30K KONA		
Längd mm	Artikel nr	Lager- vara
30	T-30K-30	Nej
33	T 20	Ja
35	T-30K-35	Nej
44	T-30K	Ja

G GÅNGAD		
Längd mm	Artikel nr	Lager- vara
40	98113-40 (G 30)	Ja
50	98113-50	Ja

ELEKTRODER KEMPPI Ø 19mm, Kona Ø 18mm, 5°

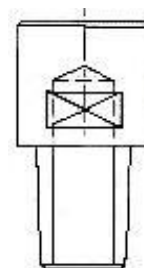
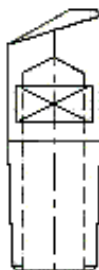
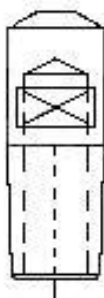

Centrisk Ø 19mm, Kona Ø 18mm, 5°		
Längd mm	Artikel nr	Lager- vara
55	5219055	Nej

Excentrisk Ø 19mm, Kona Ø 18mm, 5°		
Längd mm	Artikel nr	Lager- vara
55	5319055	Nej

Plan Ø 19mm, Kona Ø 18mm, 5°		
Längd mm	Artikel nr	Lager- vara
55	5119055	Nej

a. Elektroder

ELEKTRODER ARO Ø 10mm, Pendelelektrod Ø 22mm Kona Ø 8,9mm, 1:10

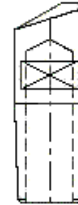
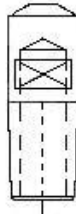
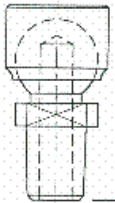

Pendel, Kona Ø 8,9 mm, 1:10		
Längd mm	Artikel nr	Lager- vara
39,25	WL 108839	Ja

Centrisk, Kona Ø 8,9 mm,		
Längd mm	Artikel nr	Lager- vara
34	WL 103534	Ja

Excentrisk, Kona Ø 8,9 mm, 1:10		
Längd mm	Artikel nr	Lager- vara
43	WL 141534	Ja

ELEKTRODER ARO Ø 12mm, Pendelelektroder Ø 22/30mm Kona Ø 11,8mm, 1:10

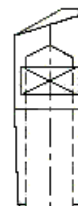
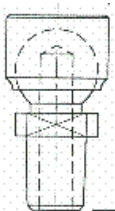

Pendel, Kona Ø 11,8 mm, 1:10		
Längd mm	Artikel nr	Lager- vara
43,25	WL 208939	Ja
45,4	WL 208943	Ja

Centrisk, Kona Ø 11,8 mm, 1:10		
Längd mm	Artikel nr	Lager- vara
34	WL 203134	Ja
42	WL 203142	Ja
55	WL 203155	Ja

Excentrisk Plan Kona Ø 11,8 mm, 1:10		
Längd mm	Artikel nr	Lager- vara
34	WL 241134	Ja
42	WL 241142	Ja

a. Elektroder

ELEKTRODER ARO Ø 12mm, Kuldedselektroder Ø 22/30mm Kona Ø 11,8mm, 1:10

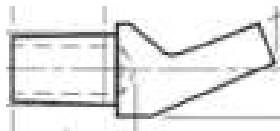

Excentrisk Special Kona Ø 11,8 mm, 1:10		
Längd mm	Artikel nr	Lager- vara
40	WL 212240	Ja

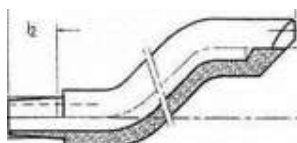

Excentrisk S-formad Kona Ø 11,8 mm, 1:10		
Längd mm	Artikel nr	Lager- vara
100	WL 210300	Ja



Excentrisk Snedställd Kona Ø 11,8 mm, 1:10		
Längd mm	Artikel nr	Lager- vara
34	WL 205134	Ja
42	WL 205142	Nej
55	WL 205154	Ja
70	WL 205170	Ja

ELEKTRODER ARO Ø 19mm, Kona Ø 17,8mm, 1:10

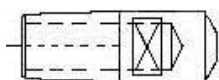

Centrisk Kona Ø 17,8 mm, 1:10		
Längd mm	Artikel nr	Lager- vara
45	WL 303145	Ja
56	WL 303156	Ja

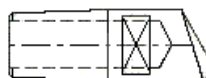

Excentrisk Plan Kona Ø 17,8 mm, 1:10		
Längd mm	Artikel nr	Lager- vara
56	WL 341156	Ja



Excentrisk Snedställd Kona Ø 17,8 mm, 1:10		
Längd mm	Artikel nr	Lager- vara
45	WL 305145	Ja
55	WL 305157	Ja

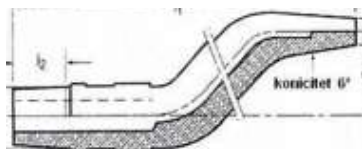

Centrisk, S-formad Kona Ø 17,8 mm, 1:10		
Längd mm	Artikel nr	Lager- vara
127	WL 310103	Ja

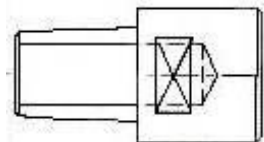

Plan, Kona Ø 17,8 mm, 1:10		
Längd mm	Artikel nr	Lager- vara
45	WL 345146	Ja